

Apex R5CR series

autarco

This mounting system uses R5 brackets rather than rail for optimal economics in commercial rooftop solar PV installations on corrugated sheet roofs.

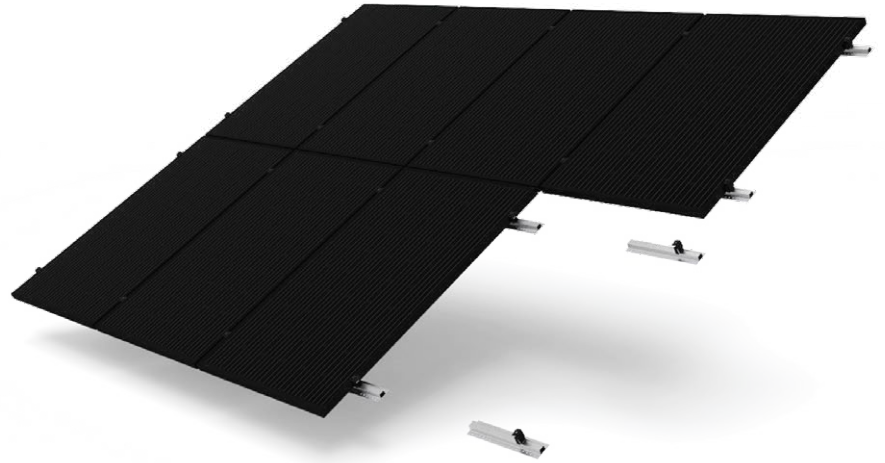

10 10-year product warranty

 Pitched roof system

 Landscape or portrait mounting

 Easy installation

 Optimal economics

QUALITY CERTIFICATES

♦ ISO 9001, 14001, 18001



PHYSICAL PROPERTIES

Maximum roof pitch	< 60°
Material	Aluminium
Suitable rooftypes	Corrugated sheet pitched roofs
Finishing	Fitted with EPDM

Bracket landscape mounting (mm)

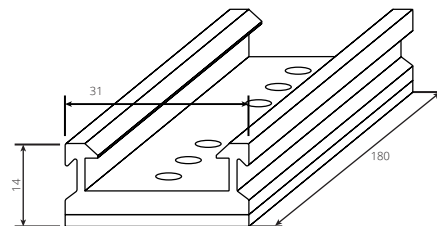

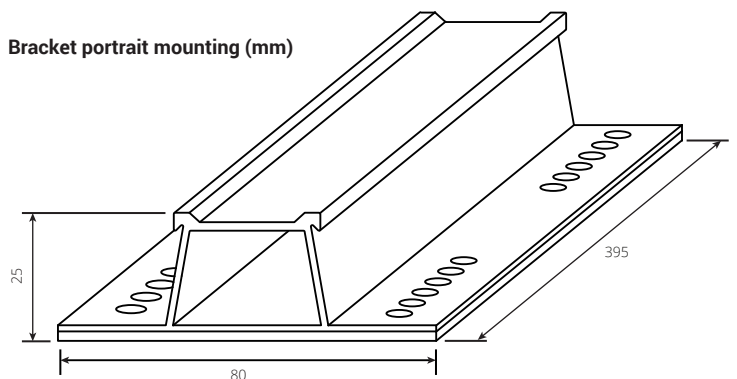

Bracket portrait mounting (mm)

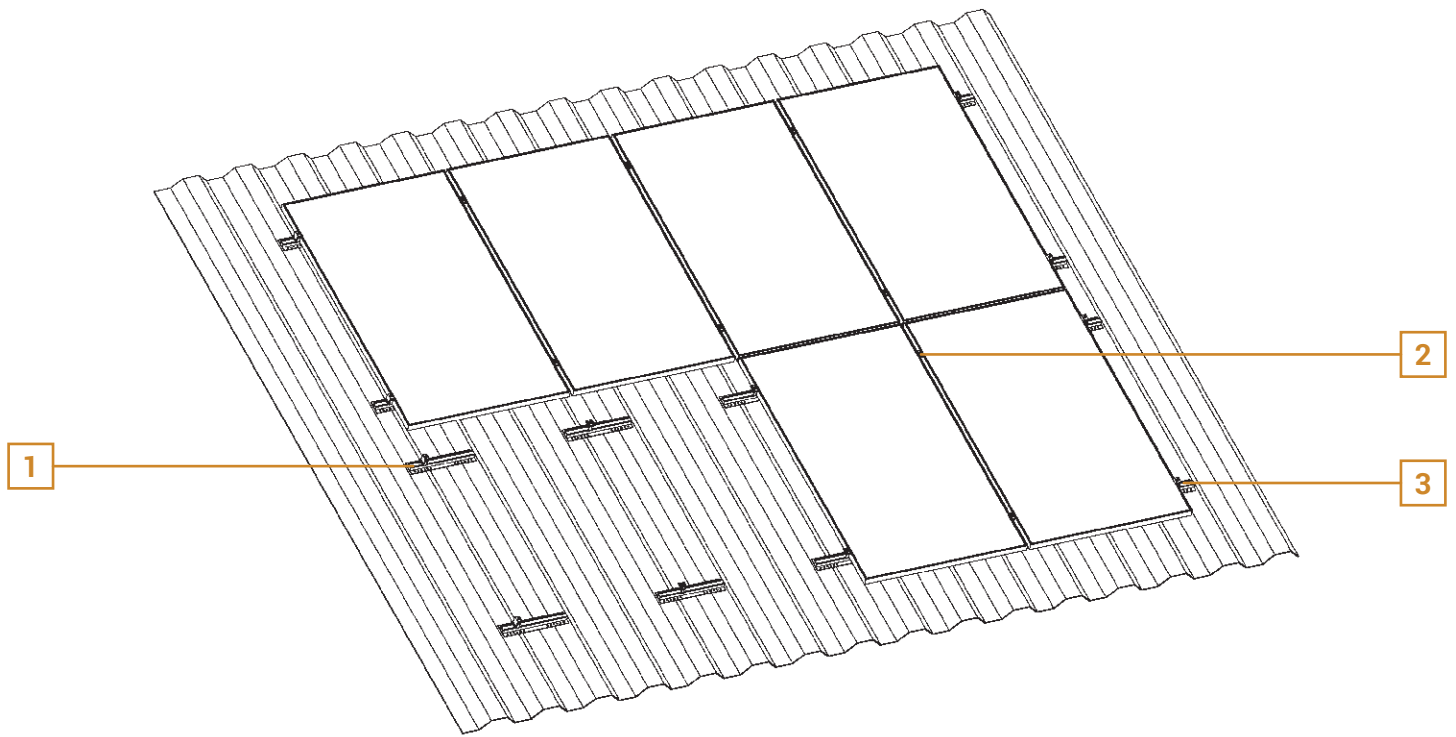



SYSTEM COMPONENTS

- 1 **R5 bracket 395mm for portrait mounting**
 M2.R5CRL395
 
- R5 bracket 180mm for landscape mounting**
 M2.R5CRL180
 

FASTENINGS

- 2 **Middle clamp**
 M1.R5(B)MC
 
- 3 **End clamp**
 M1.R5(B)EC
 

The specifications contained in this datasheet may deviate slightly from our actual products due to on-going product improvement and are subject to change at any time without prior notice.

