

Apex R5 series

autarco

The Autarco Apex R5 mounting system has grown into one of the most popular mounting systems for solar panels on pitched roofs. Thanks to the unique triangular shaped rail, a smart and stable construction with ultra-fast assembly is possible whilst ensuring the solar panels are optimally and safely supported.

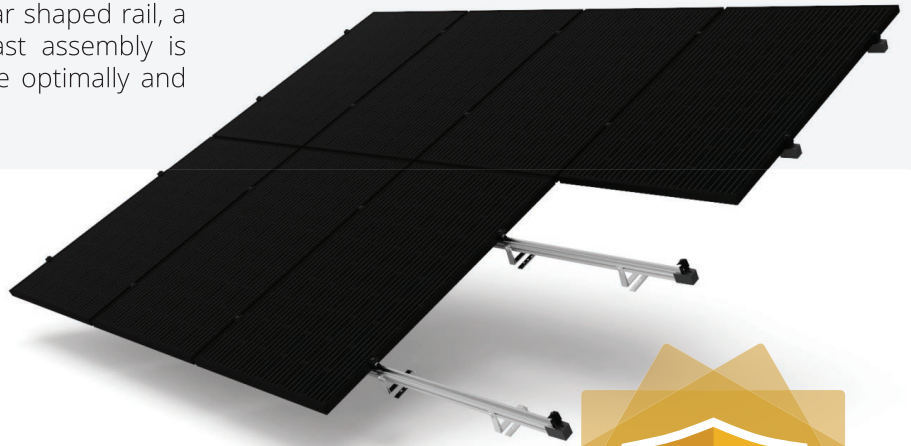

10 10-year product warranty

 Pitched roof system

 Landscape or portrait mounting

 One tool required for installation

 Lightweight yet robust

Quality certificates

- ISO 9001, 14001, 18001
- MCS012, NEN7250



Physical properties



Maximum roof pitch	< 60°
Material	Aluminium
Suitable rooftypes	All pitched roofs, corrugated roof, tiled roof (fixed or adjustable)

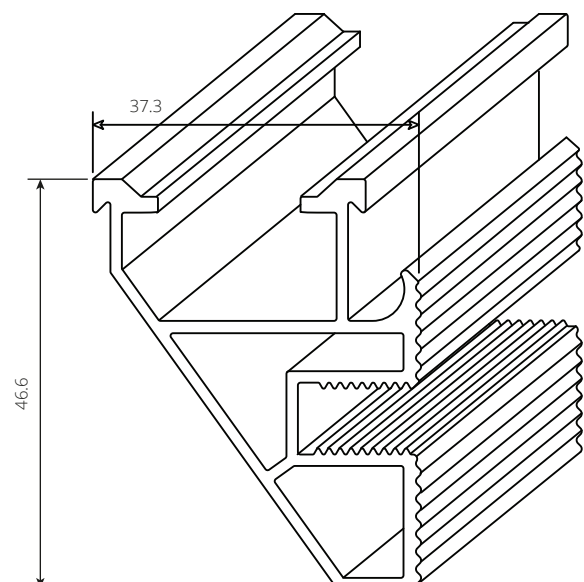

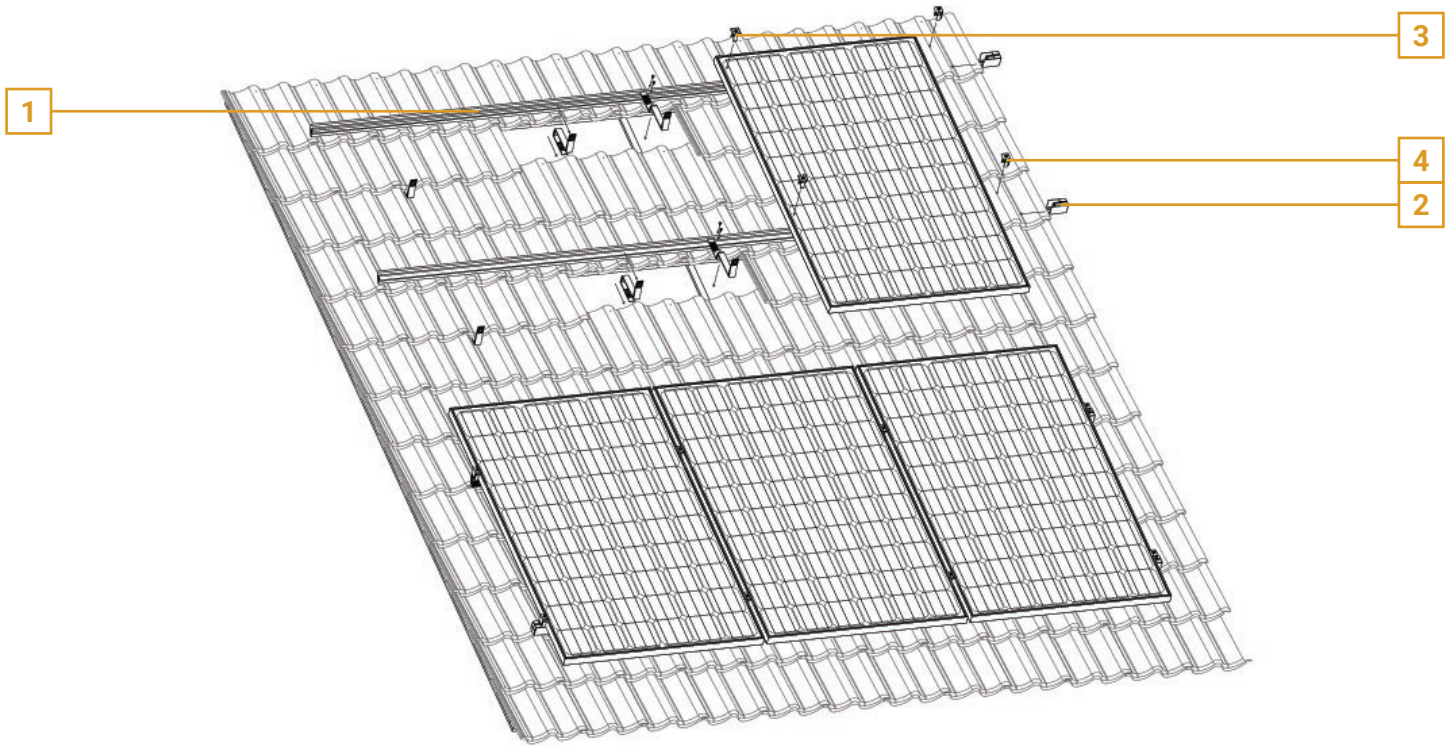
Rail section (mm)







System components

1	R5 rail M1.R5L3150 / M1.R5L4200	
2	End cap M1.R5CAP	
	Splice connector M1.R5SC	

3	Middle clamp M1.R5(B)MC	
4	End clamp M1.R5(B)EC	

Hooks

	Waveclip M2.WAVECLIP		Adjustable aluminium hook M2.THX1		Fixed stainless steel hook M2.TH1 / M2.TH2 / M2.TH4 M2.TH5 / M2.HB10L
--	--------------------------------	---	---	---	--

The specifications contained in this datasheet may deviate slightly from our actual products due to on-going product improvement and are subject to change at any time without prior notice.

