

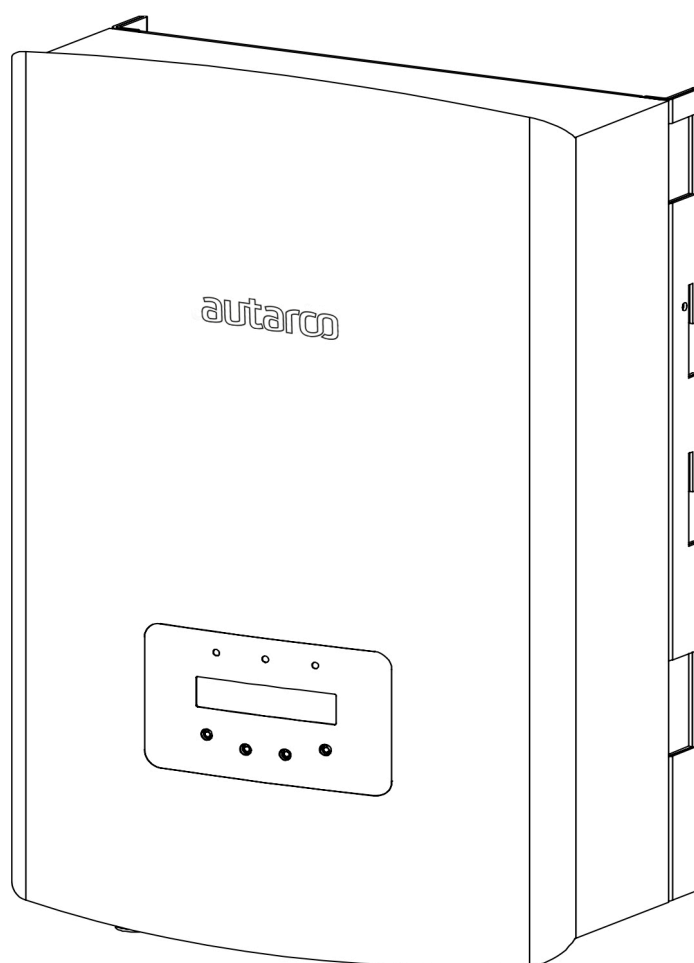

Installation and Operation Manual

Solar Inverters LX-series



Contact Information

Autarco Group B.V.
Schansoord 60
5469 DT Erp
The Netherlands

www.autarco.com
info@autarco.com

Other Information

This manual is an integral part of the unit. Please read the manual carefully before installation, operation or maintenance. Keep this manual for future reference.

Product information is subject to change without notice. All trademarks are recognized as the property of their respective owners.

© Autarco Group B.V.
All rights reserved.

Table of Contents

1.	Introduction	4
1.1	Read this first.....	4
1.2	Target Audience	4
1.3	Product versions covered by this document	5
2.	Preparation	6
2.1	Safety instructions.....	6
2.2	Package contents.....	7
2.3	Internal DC switch	7
2.4	Explanations of symbols on inverter	7
3.	Product information	8
3.1	Overview.....	8
3.2	Product identification.....	8
3.3	Product overview.....	9
4.	Installation	10
4.1	Safety.....	10
4.2	Mounting instructions	10
4.3	Safety clearance	11
4.4	Mounting procedure	12
5.	Electrical installation	13
5.1	AC connection.....	13
5.2	DC connections.....	16
5.3	Inverter commissioning sequence.....	16
6.	Operation	17
6.1	LED indicator lights	17
6.2	Inverter display.....	17
6.3	Information.....	18
6.4	Settings	18
6.5	Advanced info.....	19
6.6	Advanced Settings	19
7.	Monitoring setup and system registration	20
8.	Maintenance	20
9.	Disposal	21
10.	Troubleshooting	21
10.1	General	21
10.2	Internal component fault	21
10.3	Grid errors	22
10.4	System and design fault.....	23
11.	Product specifications	24

1. Introduction

1.1 Read this first

This manual contains important information for use during installation and maintenance of the LX-series Autarco inverter.

To reduce the risk of electrical shock, and to ensure the safe installation and operation of the LX-series Autarco inverters, the following safety symbols appear throughout this document to indicate dangerous conditions and important safety instructions.



WARNING! Indicates safety instruction, which if not correctly followed, can result in injury or property damages.



RISK OF ELECTRIC SHOCK! Indicates safety instructions, which if not correctly followed, could result in electric shock.



HOT SURFACE! Indicates safety instructions, which if not correctly followed, could result in burns.

1.2 Target Audience

This manual is intended for anyone who uses Autarco LX-series inverter. Before any further action, the operators must first read all safety regulations and be aware of the potential danger to operate high-voltage devices. Operators must also have a complete understanding of this device's features and functions.



ATTENTION! Qualified personnel means a person with valid license from the local authority in:

- Installing electrical equipment and PV power systems (up to 1000 V).
- Applying all applicable installation codes and using Personal Protective Equipment.
- Analyzing and reducing the hazards involved in performing electrical work.



WARNING! Do not use this product unless it has been successfully installed by qualified personnel in accordance with the instructions in chapter 4 "Installation".

1.3 Product versions covered by this document

The main purpose of this user manual is to provide instructions and detailed procedures for installing, operating, maintaining, and troubleshooting the LX-series of Autarco inverters which includes the following models:

For 350-450V AC grid connection:

- S2.LX6000(S)
- S2.LX10000(S)
- S2.LX15000(S)

For 200-240V AC grid connection:

- S2.LX6000-LV(S)
- S2.LX10000-LV(S)

The “S2.” In the product code means the product is a grid-tied inverter. If the product has an “S” at the end it comes with integrated DC switches.

The item code or SKU will include an additional number at the end. The final number references the default grid standard and colour of inverter. For example, S2.LX6000S.1 is the 6kW model with Dutch grid standard as default, integrated DC switch and Autarco blue cover.

Please keep this user manual available at all times in case of emergency.

2. Preparation

2.1 Safety instructions



DANGER! Do not touch any internal components whilst the inverter is in operation.



DANGER! Do not stand close to the inverter during severe weather conditions such as lightning, etc.



Make sure you completely cover the surface of all PV arrays with opaque (dark) material before wiring them or make sure the DC circuit breaker or equivalent DC isolator is disconnected. This is because photovoltaic (PV) arrays create electrical energy when exposed to light, and could cause a hazardous condition.



The LX series inverter must only be operated with PV arrays of protection class II, in accordance with IEC 61730, class A.



WARNING! The PV inverter will become hot during operation; please don't touch the heat sink or peripheral surface during or shortly after operation.



NOTICE! Do not directly connect AC output of the inverter to any private AC equipment. The PV inverter is designed to feed AC power directly into the public utility power grid.



WARNING! The installation, service, recycling and disposal of the inverters must be performed by qualified personnel in compliance with national and local standards and regulations. Please contact your dealer to get the information of authorized repair facility for any maintenance or repairmen.

Any unauthorized actions including modification of product functionality of any form will affect the validation of warranty service; Autarco may deny the obligation of warranty service accordingly.

2.2 Package contents

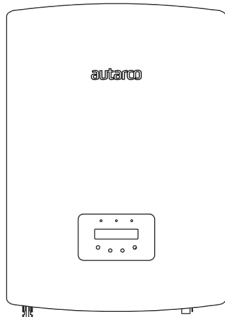

Autarco LX-series inverter

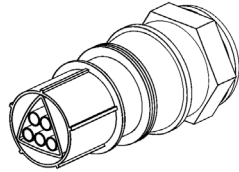

AC plug

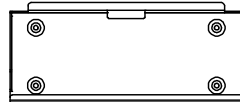

Mounting bracket

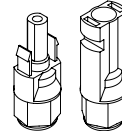

MC4 connector pairs
S4.MC4F/MC4M

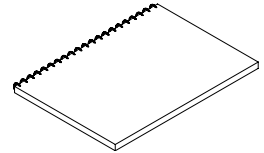

Instruction manual

2.3 Internal DC switch

Please verify whether your Autarco LX-series inverter is equipped with an internal DC switch. This switch can be found on the bottom of the inverter (see 3.3). If there isn't an internal DC switch it is important to apply an external DC disconnect in order to completely disconnect the solar PV module strings from the inverter.

2.4 Explanations of symbols on inverter



DANGER - HIGH ELECTRIC VOLTAGE

This device is directly connector to public grid. All work to the inverter shall be carried out by qualified personnel only. There might be residual currents in inverter for up to 10 minutes because of large capacitors.



ATTENTION

This device directly connected to electricity DC generators and the public AC grid.



DANGER – HOT SURFACES

The components inside the inverter will get hot during operation, DO NOT touch aluminum housing during operating.



ATTENTION

In case of any work to the inverter, always refer to this manual for detailed product information.



ATTENTION

This device SHALL NOT be disposed of in residential waste. Please go to Chapter 9 “Recycling and Disposal” for proper treatments.



CE MARK

This equipment conforms to the basic requirements of the EU guideline governing low voltage and electromagnetic compatibility.

3. Product information

3.1 Overview

Autarco LX-series grid tied inverters are state of the art, high efficiency, robust and reliable grid tied inverters at the best price quality ratio available. They are easy to install and carry a standard 5 year product warranty which is extendable to 15 years. Our rigorous quality control and testing facilities guarantee Autarco inverters meet the highest quality standards possible. These inverters are the key to our international track record of delivering extremely reliable solar power solutions.

Key features:

- Maximum efficiency of 98%
- Wide MPPT voltage range
- Low turn off voltage
- High enclosure protection class IP65
- Available in 350-450V AC for LX 6000(S),10000(S),15000 (S)
- Silent design using convection cooling principle
- Standard 5 year product warranty, extendable to 15 years
- RS485 communication port for Wi-Fi, LAN, GPRS or Z-Wave based monitoring.
- Optional integrated DC switch
- Available in 200-240V for LX 6000-LV(S),10000-LV(S)

For full specifications please see chapter 11 “Product specifications”.

3.2 Product identification

You can identify the inverter by the serial number (S/N) sticker on the side of the inverter. Important electrical specification can also be found on the label which can be found on the right side of the inverter housing. Do not remove the label or the serial number as this voids the product warranty.

3.3 Product overview

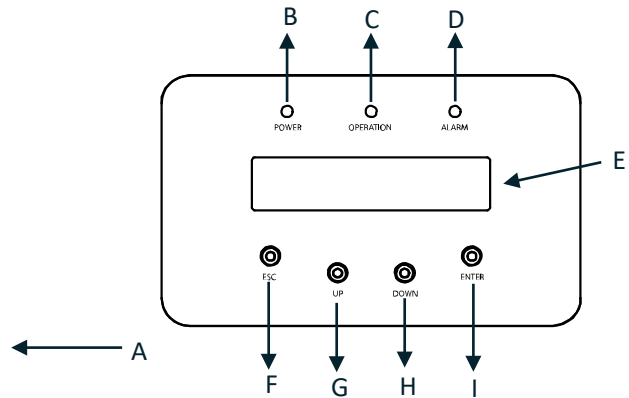
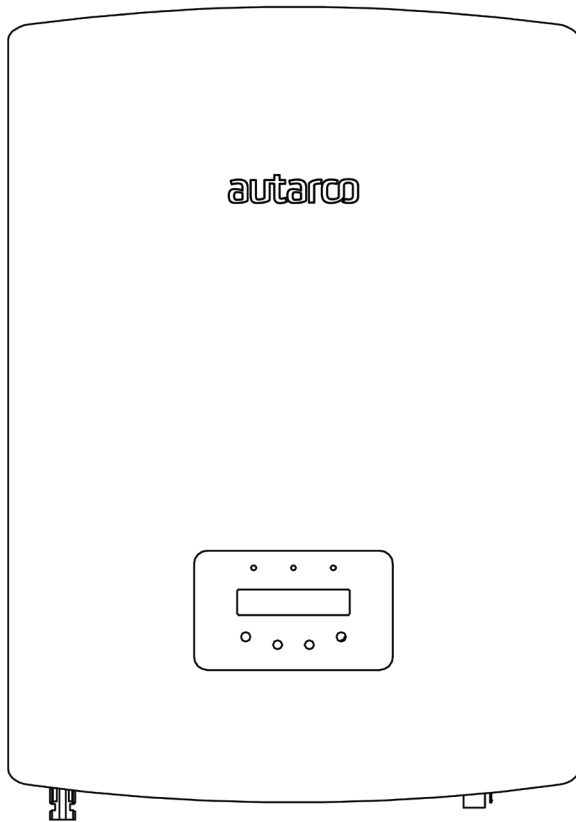

- A: Inverter cover
- B: LED light – POWER
- C: LED light – OPERATION
- D: LED light – ALARM
- E: LCD display 2x16 characters
- F: Escape key
- G: Up key
- H: Down key
- I: Enter key
- J: DC +
- K: DC -
- L: DC switch (optional)
- M: Communication port
- N: AC output

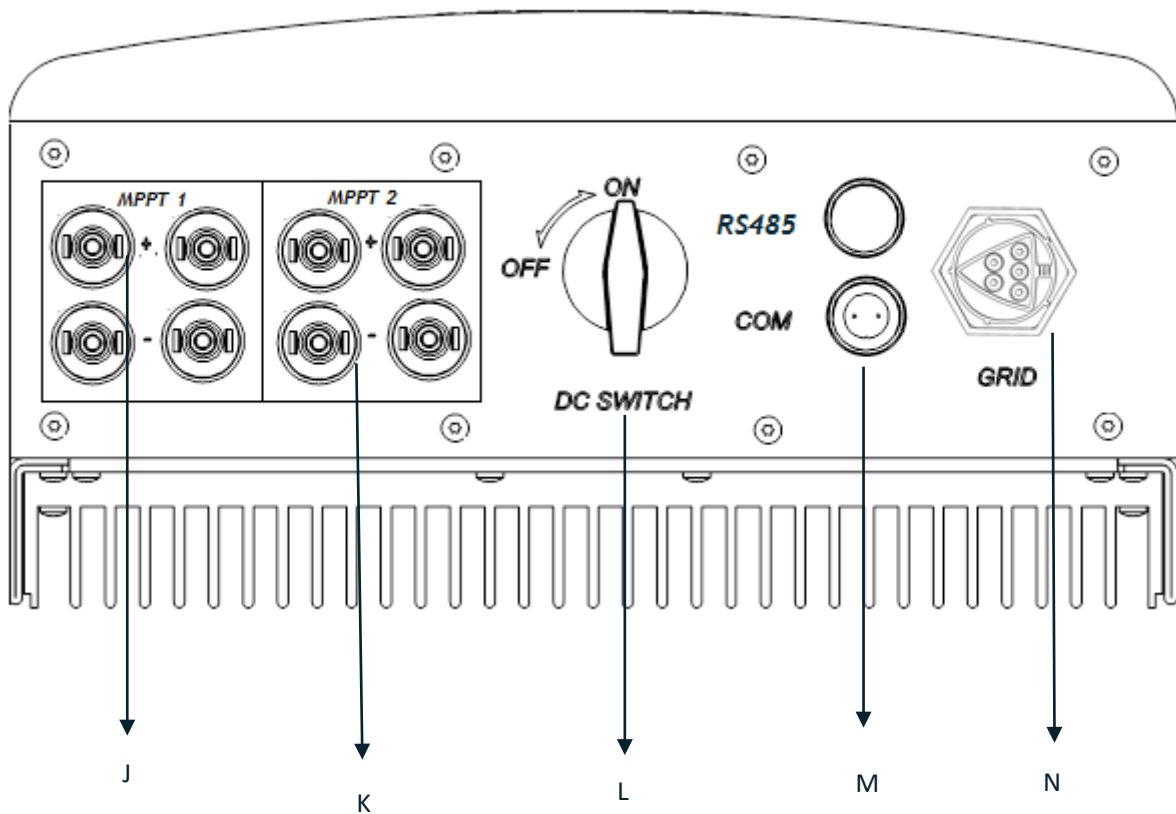

4. Installation

4.1 Safety



DANGER! Do not install the inverter near flammable or explosive items.



WARNING! The installation must be performed by qualified personnel and in compliance with national and local standards and regulations.
This inverter will be connected to a high voltage DC power generator and AC grid. Inappropriate installation may also jeopardize the life span of the inverter.



The installation site must have good ventilation conditions. Direct exposure to intense sunshine is not recommended.

4.2 Mounting instructions

- The inverter is suitable for outdoor and indoor installation.
- Vertical installation is recommended, with a maximum inclination of 15° backwards.
- Make sure the mounting wall is strong enough to hold the weight of the inverter.
- The ambient temperature of installation site should be between -20 °C and +60 °C.
- It is not recommended that the inverter is exposed to the direct sunshine.
- Make sure of ample ventilation at installation site, insufficient ventilation may reduce the performance of the electronic components inside the inverter and shorten the life span of the inverter.

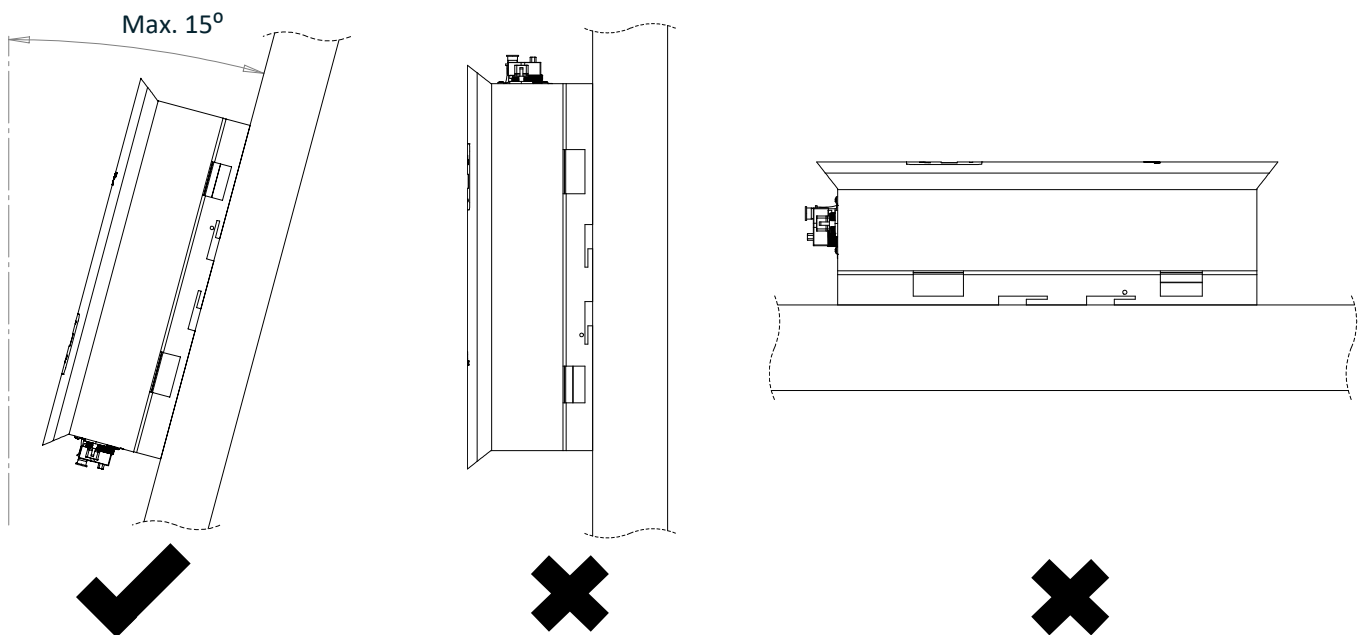

4.3 Safety clearance



Caution! Make sure heat sinks are out of reach of children.

Observe the following minimum clearances to walls:

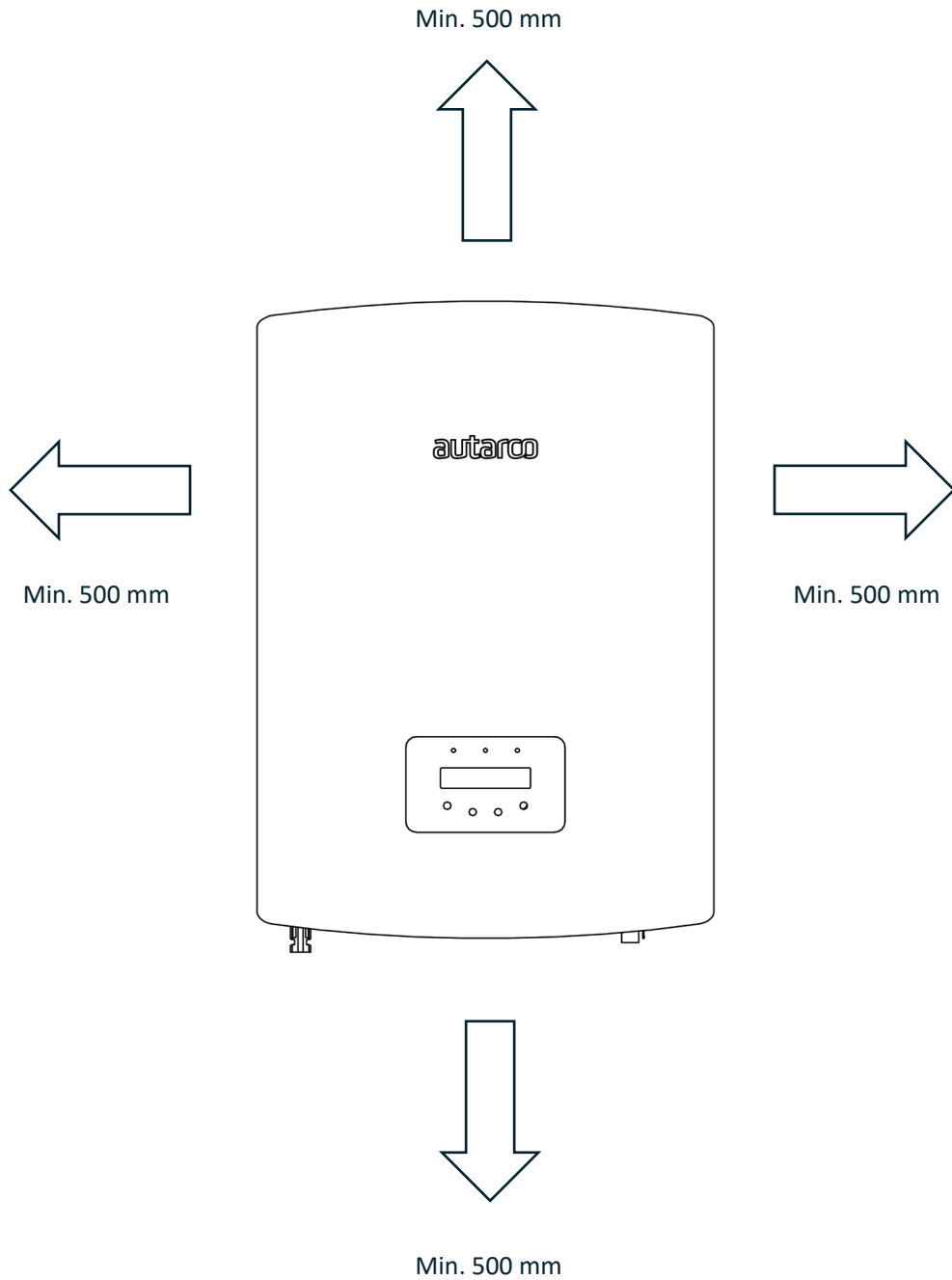

4.4 Mounting procedure

Step 1 — Mount the wall bracket onto the mounting wall with appropriate screws plugs.

Step 2 — Lower the inverter onto the bracket.

Step 3 — Use M4x14 stainless steel screws at holes marked below to secure the mounting hooks to the rear of the inverter.

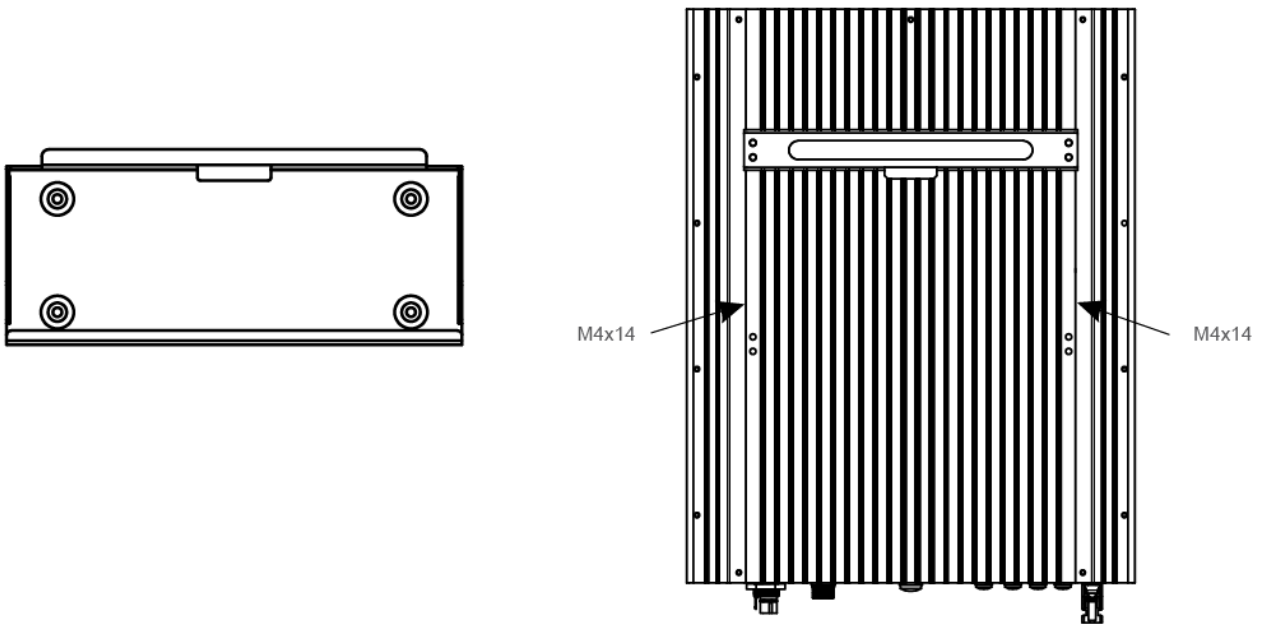

5. Electrical installation



DANGER! This inverter will be connected to a high voltage DC power generator and AC grid. The installation must be performed by qualified personnel and in compliance with national and local standards and regulations

5.1 AC connection



DANGER! Never connect or disconnect the connectors under load.



NOTICE! The AC connection to the electrical distribution grid must be performed only after receiving authorization from the utility that operates the grid.



NOTICE! Make sure to set the correct grid standard as part of system commissioning, see chapter 6.6.

The Autarco inverter is equipped with an integrated Residual Current Protective Device (RCPD) and Residual Current Operated Monitor (RCOM). The RCOM will detect the volume of the leakage current and compare it with the expected value, if the leakage current exceeds the permitted range, the RCPD will disconnect the inverter from the AC load.

If regulations in the country of installation stipulate an external Residual Current Device (RCD), you must use a device with a tripping threshold of 100 mA or more. A type "A" RCD can be used in accordance with our **"Manufacturer's declaration for usage of residual current devices with Autarco SX, MX and LX grid-tied inverters."**

The AC cable used must be dimensioned in accordance with any local and national directives on cable dimensions which specify requirements for the minimum conductor cross-section. Cable dimensioning factors are e.g.: nominal AC current, type of cable, type of routing, cable bundling, ambient temperature and maximum specified line losses.

We recommend 6mm 105 °C cable with resistance lower than 1.5 ohm.

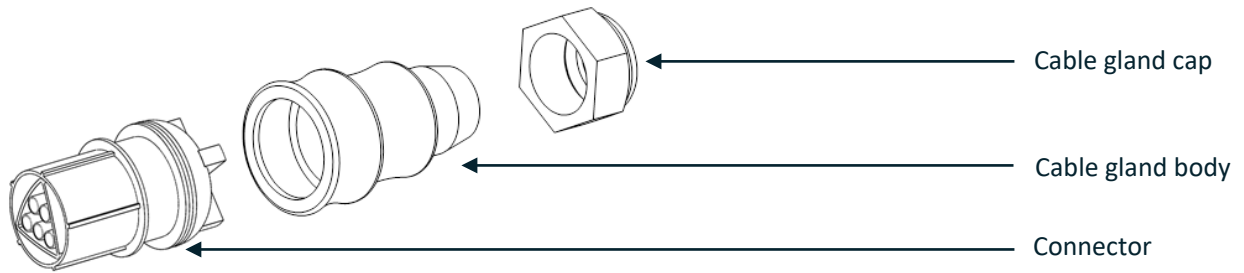

Step 1 — Slide the cable gland cap, cable gland body and adapter to the cable.

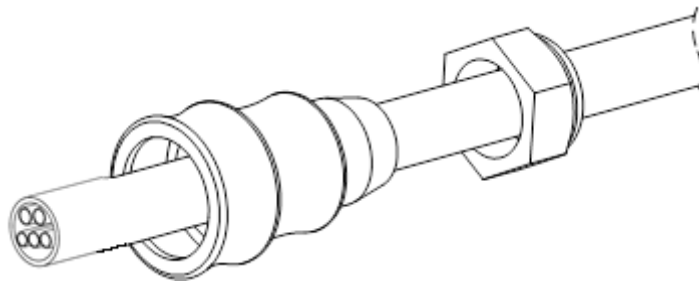

Step 2 — Strip outer jacket 60mm and strip each cable insulation about 12 ± 1 mm.

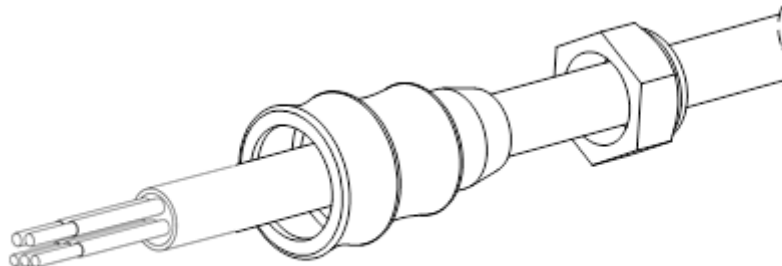

Step 3 — Insert cable strands into connector socket, and lock the screws. Make sure to fit the ground wire into the PE hole.

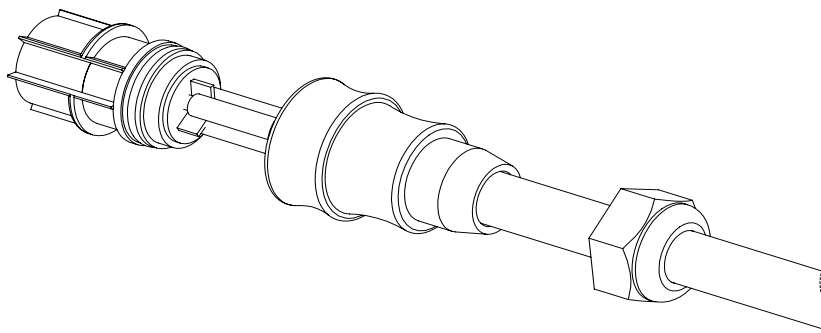

Step 4 — Fit the adapter, cable gland body and cable glad cap to the connector as per below.

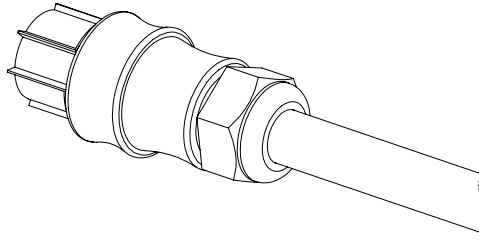

NOTICE! It is important that the AC wires are connected to the right terminals as indicated by the “L”, “N” and “Earthing” symbols on each AC connector. In some countries a second protective conductor is required as a matter of principle. In each case, observe the applicable regulations for the site.



The AC connection to the electrical distribution grid must be performed only after receiving authorization from the utility that operates the grid.

Always use separate fuses for consumer load. Use dedicated circuit breakers with load switch functionality for load switching.

The selection of the mains circuit breaker rating depends on the wiring design (wire cross- section area), cable type, wiring method, ambient temperature, inverter current rating etc. Derating of the circuit breaker rating may be necessary due to self-heating or if exposed to heat.

	S2.LX6000(S)	S2.LX10000(S)	S2.LX15000(S)	S2.LX6000-LV (S)	S2.LX10000-LV (S)
Max. AC current (A)	15	18	18	18	18
Recommended fuse type gL/gG or comparable automatic circuit breaker rating (A)	25	25	25	16	25



DANGER! No consumer load should be applied between the mains circuit breaker and the inverter.

5.2 DC connections



DANGER! Never connect or disconnect the connectors under load.

LX-series inverters have two MPP trackers. The DC characteristics of each model is shown in the table below:

Inverter	MPP tracker	Max DC power	Max DC voltage	Max. DC current per MPPT
S2.LX6000(S)		6900W		15A
S2.LX10000(S)	2	11500W	1000V	18A
S2.LX15000(S)		17200W		
S2.LX6000-LV (S)	2	6900W	600V	18A
S2.LX10000-LV (S)		11500W	600V	18A



DANGER! Do not connect the strings with an open circuit voltage greater than the Max DC voltage of the inverter.

To connect the PV generator to the inverters we use 4mm² or 6mm² PV cable and MC4 connectors. For details on how to assemble MC4 connector please refer our MC4 connector manual.



DANGER! For protection against electric shock, MC4 connectors must be isolated from the PV array while being assembled or disassembled.



DC connections must not be unplugged while under load. They can be placed in a no-load state by switching off the DC/AC converter or breaking the DC circuit interrupter. Plugging and unplugging while under voltage is permitted.



CAUTION! MC4 connectors are watertight IP67 but cannot be used permanently under water. Do not lay the MC4 connectors on the roof surface.



If any tools or parts are used in the MC4 connector assembly other than those listed in the MC4 connector manual, neither safety nor compliance with the technical data can be guaranteed.

5.3 Inverter commissioning sequence

Turn ON	Turn OFF
1. Connect AC side (if not connected yet)	1. Switch OFF the AC switch
2. Connect DC side (if not connected yet)	2. Switch OFF the DC switch
3. Switch ON the DC switch	
4. Switch ON the AC switch	

6. Operation

6.1 LED indicator lights

There are three LED status indicator lights in the front panel of LX series inverters. The left POWER light (red) indicates power status of the inverter. The middle OPERATION light (green) indicates the operation status. The right ALARM light (yellow) indicates the alarm status. Table 3.1 explains their meanings.

Light	Status	Description
● POWER (red)	ON	The PV array provides power to the inverter
	OFF	The PV array does not provide power to the inverter
● OPERATION (green)	ON	The inverter is feeding AC power to the grid
	OFF	The inverter is not feeding AC power to the grid
	FLASHING	The inverter is initializing
● ALARM (yellow)	ON	There is a fault. Refer to the inverter display and chapter 10 of this manual for details
	OFF	The inverter is operation normally

When inverter DC switch and AC switch have been turned on the inverter will start initializing. After approx. 3 minutes the inverter will start normal operation with the inverter display showing GENERATING.

6.2 Inverter display



NOTICE! During normal operation, make sure the optional integrated DC switch is switched “on”.

The display content consists of 2 lines. During regular operation the display shows the current power and operation status alternatively for 10 seconds. Pressing the UP or DOWN buttons will manually cycle through these two displays. Pressing the ENTER button gives access to the main menu which has four sub menus:

- Information, described in detail in chapter 6.3.
- Settings, described in detail in chapter 6.4.
- Advanced information, described in detail in chapter 6.5.
- Advanced settings, described in details in chapter 6.6.

By pressing UP or DOWN keys you can cycle through these sub menus and click ENTER to go into the submenu.

6.3 Information

The LX series inverters main menu provides access to operational data and information. The information is displayed by selecting "Information" from the main menu. By default the inverter display will scroll through the information states below. Pressing the ENTER key will lock or unlock the current display. You can also press UP or DOWN keys to manually scroll through. By pressing the ESC key returns to the main menu.

State	Description
V_DC1 %VALUE%	Shows the input voltage (V) of the MPPT1
I_DC1 %VALUE% A	Shows the input current (A) of the MPPT1
V_DC2 %VALUE%	Shows the input voltage (V) of the MPPT2
I_DC2 %VALUE% A	Shows the input current (A) of the MPPT2
V_AC %VALUE%	Shows the voltage (V) of the grid
I_AC %VALUE% A	Shows the current (A) of the grid
Status: %VALUE%	Shows the status of the inverter
Power: %VALUE% W	Shows current output power (W) of the inverter
	For any status other than "Generating" and "Initializing" please refer to chapter 10 for troubleshooting
Grid frequency	Shows current frequency (Hz) of the grid
F_Grid %VALUE% Hz	
Total Energy	Shows total energy output (kWh)
%VALUE% kWh	
This Month: %VALUE% kWh	Total energy output in this month (kWh)
Last Month: %VALUE% kWh	Total energy output of last month (kWh)
This day: %VALUE% kWh	Total energy output in this day (kWh)
Last day: %VALUE% kWh	Total energy output of yesterday (kWh)

6.4 Settings

The following options are available under the Settings submenu:

Set Time and Date	Press UP/DOWN keys to set change element Press ENTER key to move to next element Press ESC key to save date and return
Set Address	Assign a number (##) to the inverter to distinguish between multiple inverters on a single Wi-Fi device. Not necessary for installations of single inverters. Press UP/DOWN keys to set change number Press ENTER key to save the setting Press ESC key to return
Restore Settings	Delete alarm messages that have been generated

6.5 Advanced info



WARNING! Access to this section of the menu is for Autarco qualified and accredited technicians only. Unauthorized access will void the product and system warranty.

Screen can be scrolled through with UP/DOWN keys to see the information as per the table below. Press ENTER key to enter a submenu. Press ESC key to go back to the main menu.

Alarm Messages	<p>Scroll through the last ten alarm messages for trouble shooting purposes.</p> <p>Press UP/DOWN keys to cycle through alarm messages</p> <p>Press ESC key to return</p>
Temperature	The screen shows the temperature of the inverter in degrees Celcius.
Standard NO.	The screen shows the current grid standard
Version	The screen shows the operating software version of the inverter
Communication data	The screen shows information interpretable to qualified technicians only



6.6 Advanced Settings



WARNING! Access to this section of the menu is for Autarco qualified and accredited technicians only. Unauthorized access will void the product and system warranty.

Screen can be scrolled through with UP/DOWN keys to see the information as per the table below. Press ENTER key to enter a submenu. Press ESC key to go back to the main menu.

Select grid standard	<p>WARNING! Set GRID OFF (see below) before changing this setting.</p>
	<p>Press UP/DOWN keys to cycle through available standards</p> <ul style="list-style-type: none"> • AS4777 • VDE0126 • UL1741 • G83 • User defined <p>Press ENTER key to save the setting Press ESC key to cancel and return</p> <p>When selecting User defined the following upper and lower values have to be set for voltage and frequency: OV-V: 240-270V UV-V: 180-210V OV-G-F: 50.3-52.0Hz (60.3-62.0Hz) UV-G-F: 47.0-49.5Hz (57.0-59.5Hz) Press UP/DOWN keys to scroll through these values</p>

	<p>Press ENTER key to edit the selected value Press UP/DOWN keys to change the selected value Presss ENTER key to save and return Press ESC key to cancel and return</p> <p> WARNING! Set GRID ON (see below) before new standard is activated.</p> <p> WARNING! Please note that the User-Def standard is not to be used without the agreement of the local grid authority.</p>
Grid ON/OFF	<p>Press UP/DOWN keys to cycle through grid ON/OFF options Press ENTER key to save Press ESC key to return</p>
Clear Energy	Reset the inverters total kWh output to zero.
New Password	Change the password to enter Advanced Info and Advanced Settings.
Calibrate Energy	Calibrate the device –Adjust Inverters total kwh output

7. Monitoring setup and system registration

The instructions about monitoring setup and system registration can be found in separate manuals enclosed in the documentation that came with this Autarco system. For more information manual please contact your Autarco installer or refer to our website www.autarco.com.

8. Maintenance

The LX-series inverters do not require regular maintenance. However, impurities such as dust and dirt accumulation on the heat sink may negatively affect the inverter's ability to dissipate heat. Any dirt or dust can be removed with a cloth or soft brush.



CAUTION! Do not touch the heat sink when the inverter is in operation. Turn OFF the inverter (see section 5.3) and allow for cooling down before cleaning.



CAUTION! Never use any solvents, abrasives or corrosive materials to clean the inverter.

9. Disposal

To comply with European Directive 2002/96/EC on waste Electrical and Electronic Equipment and its implementation as national law, electrical equipment that has reached the end of its life must be collected separately and returned to an approved recycling facility. Ignoring this EU Directive may have severe effects on the environment and your health.

10. Troubleshooting

10.1 General

Display message	Action
Blank screen	<ul style="list-style-type: none"> • Check that all switches are in the ON position (including internal DC switch if present) • Check AC and DC power supply. If DC power is greater than 10W and string voltage greater than 100V the inverter should start. • If switches are on and AC and DC power supplies is available please contact installer.

10.2 Internal component fault

Error type	Display message	Error code	Error description	Action
Over BUS DC voltage	OV-BUS	1021	Internal fault	<ol style="list-style-type: none"> 1. Restart inverter (up to three times). 2. If error persists contact installer for replacement inverter.
Under BUS DC voltage	UN_BUS	1012	Internal fault	
BUS pressure fault	UNB2_BUS	1024	Internal fault	
System initial fault	INI-PRO	1031	Internal fault	
Relay fault	Relay_PRO	1035	Internal fault	
DSP_B fault	DSP_B_PRO	1036	Internal fault	
DC injection	DCInj_PRO	1037	Internal fault	
12V under voltage fault	12Power_PRO	1038	Internal fault	

10.3 Grid errors

Error type	Display message	Error code	Error description	Action
Over voltage	OV-G-V	1010	Grid voltage exceeds the standard set in the inverter	<ol style="list-style-type: none"> 1. Wait to see if the grid voltage returns within limits. 2. If problem persists, check whether the grid standard is set correctly in Advanced Settings (see 6.6). 3. Check V_AC, grid voltage, in Information display of inverter (see 6.3) and perform independent measurement of grid voltage to confirm that the inverter reading is correct. If the measured voltage is outside the local grid standard limits, please contact your local utility as it may require monitoring and adjustment 4. With agreement from utility it is possible to set a user defined voltage range (see 6.6).
Under voltage	UN-G-V	1011	Grid voltage is below the standard set in the inverter	
Over frequency	OV-G-F	1012	Grid frequency exceeds the standard set in the inverter.	<ol style="list-style-type: none"> 1. Wait to see if the grid frequency returns within limits. 2. If a problem persists, check whether the grid standard is set correct in Advanced Settings (see 6.6). 3. Check grid frequency, in Information display of inverter (see 6.3) and perform independent measurement of grid frequency to confirm that the inverter reading is correct. If the measured frequency is outside the local grid standard limits, please contact your local utility as it may require monitoring and adjustment. 4. With agreement from utility it is possible to set a user defined frequency range (see 6.6).
Under frequency	UN-G-V	1013	Grid frequency is below the standard set in the inverter.	
Grid impedance	G-IMP	1014	High grid impedance	<ol style="list-style-type: none"> 1. Wait to see if the grid returns within limits. 2. If problem persists please contact your local utility as it may require monitoring and adjustment.
No Grid	NO Grid	1015	The inverter cannot detect a grid.	<ol style="list-style-type: none"> 1. Check your AC power connections and switches. 2. Restart the inverter. 3. Call your local grid to resolve the black out.

10.4 System and design fault

Error type	Display message	Error code	Error description	Action
Over DC voltage	OV-DC	1020	The DC input of the solar strings exceeds the inverters limits.	<ol style="list-style-type: none"> 1. Restart inverter (up to three times). 2. Contact installer to: <ol style="list-style-type: none"> a. Perform independent measurement of string voltage to confirm that the inverter reading is correct. 3. Rewire strings so that string voltage is within accepted range.
Over temperature	TEM-PRO	1032	The internal temperature of inverter exceeds limits.	<ol style="list-style-type: none"> 1. Check location of inverter. Ensure it has adequate ventilation and is not exposed to direct sunlight. 2. Contact installer to replace inverter in case problem persists.
Short circuit fault	SHORT-PRO	1030	A short circuit has been detected in the system.	<ol style="list-style-type: none"> 1. Restart inverter (up to three times). 2. Call installer to: <ol style="list-style-type: none"> a. Check for pinched, crimped or otherwise damaged cables and connections. b. Check all switches for short circuit. 3. If error persists contact Autarco for replacement inverter.
Ground fault	GROUND-PRO	1033	Current flow detected through ground conductor.	<ol style="list-style-type: none"> 1. Restart inverter (up to three times). 2. Call installer to: <ol style="list-style-type: none"> a. Check if there is any current on the ground conductor using a clamp meter. b. Check for pinched, crimped or otherwise damaged cables and connections. 3. If error persists contact Autarco for replacement inverter.
Current leakage	ILeak_PRO	1034	A current leak has been detected.	<ol style="list-style-type: none"> 1. Restart inverter (up to three times). 2. Call installer to: <ol style="list-style-type: none"> a. Check if there is any current on the ground conductor using a clamp meter. b. Check for pinched, crimped or otherwise damaged cables and connections. 3. If error persists contact Autarco for replacement inverter.

11. Product specifications

	S2.LX6000(S)	S2.LX10000(S)	S2.LX15000(S)
Input			
Max. DC voltage (V)	1000	1000	1000
MPPT voltage range (V)	200-800	200-800	200-800
Number of MPP trackers	2	2	2
Max. DC current per MPPT (A)	15	18	18
DC connection type	MC4	MC4	MC4
Number of DC inputs per MPPT	1	2	2
Turn on voltage (V)	330	330	330
Turn off voltage (V)	180	180	180
Output			
Nominal AC power (W)	6000	10000	15000
Max. AC power (W)	6600	11000	16500
Max. AC current (A)	10.0	16.7	25
Power connection	Three phase		
Grid voltage range	According to CQC, VDE 0126-1-1, NB/T32004, G59/3, AS4777		
Grid frequency range	According to VDE 0126-1-1, UL1741, G83/2, AS4777		
Power factor	>0.99		
Harmonic distortion at nominal output	<3%		
AC connector	IP67 rated plug		
Overvoltage category	OVC III (MAINS), OVC II (PV)		
Power consumption			
Nighttime power consumption (W)	< 1		
Standby power consumption (W)	6		
Efficiencies			
Max. efficiency	>98.2%	>98.2%	>98.3%
Euro efficiency	>97.3%	>97.3%	>97.5%
MPPT efficiency	99.9%	99.9%	99.9%

	S2.LX6000(S)	S2.LX10000(S)	S2.LX15000(S)
Safety protection			
Internal overvoltage protection		Yes	
DC Insulation monitoring		Yes	
Earth fault protection		Yes	
Grid monitoring		Yes	
Earth fault current monitoring	According to VDE 0126-1-1, UL1741, G83/2, AS4777		
DC current monitoring	According to VDE 0126-1-1, UL1741, G83/2, AS4777		
Islanding protection		Yes	
CE- compliant	According to EN61000-3-2:2006+A1, EN61000-3-3:2008, EN61000-6-1:2007, EN61000-6-2:2005, EN61000-6-3:2007, EN61000-6-4:2007, EN55022:2010, EN50178:1997, IEC62109-1:2010, IEC62109-2:2011, EN50438		
General data			
Dimensions (W x H x D) (mm)	430 X 600 X 220	430 X 600 X 220	430 X 600 X 220
Weight	27kg	27kg	30kg
Installation environment	Indoor or outdoor		
Mounting	Wall bracket		
Operating temperature range (°C)	-25 to 60		
Max. relative humidity	95% (without condensation)		
Maximum altitude	2000m		
IP protection rating	IP65 according to EN60529		
Isolation type	Transformerless		
Cooling concept	Convection		
Noise level (dB)	< 30		
LED indicators	3		
LCD display	16 x 2 character		
Communication interfaces	RS485		
Optional interfaces	Wi-Fi 802.11, RS232, RJ45, GPRS		
Standard warranty	5 years (extendable to 15 years)		
Integrated DC switch	Optional		

	S2.LX6000-LV (S)	S2.LX10000-LV (S)
Input		
Max. DC voltage (V)	600	
MPPT voltage range (V)	150-500	
Number of MPP trackers	2	2
Max. DC current per MPPT (A)	18	18
DC connection type	MC4	MC4
Number of DC connections per MPPT	1	2
Turn on voltage (V)	170	170
Turn off voltage (V)	100	100
Output		
Nominal AC power (W)	6000	10000
Max. AC power (W)	6600	11000
Nominal AC current (A)	16.63/15.72/14.36	16.63/15.72/14.36
Max. AC current (A)	18.3/17.3/15.8	18.3A/17.3A/15.8A
Power connection	Three phase	
Grid voltage range	According to VDE 0126-1-1, UL1741, G59/3, AS4777	
Grid frequency range	According to VDE 0126-1-1, UL1741, G83/2, AS4777	
Power factor	>0.99	
Harmonic distortion at nominal output	<3%	
AC connector	IP67 rated plug	
Overvoltage category	OVC III (MAINS), OVC II (PV)	
Power consumption		
Nighttime power consumption (W)	< 1	
Standby power consumption (W)	6	
Efficiencies		
Max. efficiency	>97.2%	>97.2%
Euro efficiency	>96.2%	>96.2%
MPPT efficiency	99.9%	99.9%

	S2.LX6000-LV (S)	S2.LX10000-LV (S)
Safety protection		
Internal overvoltage protection	Yes	
DC Insulation monitoring	Yes	
Earth fault protection	Yes	
Grid monitoring	Yes	
Earth fault current monitoring	According to VDE 0126-1-1, UL1741, G83/2, AS4777	
DC current monitoring	According to VDE 0126-1-1, UL1741, G83/2, AS4777	
Islanding protection	Yes	
CE- compliant	According to EN 62109, EN 61000-6-1, EN 61000-6-3, EN 61000-6-2, EN 61000-6-4, EN61000-3-2, EN61000-3-3, EN61000-3-12, EN61000-3-11	
General data		
Dimensions (W x H x D) (mm)	430 X 600 X 220	
Weight	27kg	
Installation environment	Indoor or outdoor	
Mounting	Wall bracket	
Operating temperature range (°C)	-25 to 60	
Max. relative humidity	95% (without condensation)	
Maximum altitude	2000m	
IP protection rating	IP65 according to EN60529	
Isolation type	Transformerless	
Cooling concept	Convection	
Noise level (dB)	< 30	
LED indicators	3	
LCD display	16 x 2 character	
Communication interfaces	RS485	
Optional interfaces	Wi-Fi 802.11, RS232, RJ45, GPRS	
Standard warranty	5 years, extendable to 15 years	
Integrated DC switch	Optional	